

Caxtool Kft.
6791 Szeged, Dorozsmai út 157. EU
+36 62 509 909
info@caxtool.hu
Adószám: 12871856-2-06
Adószám: HU 12871856

Bankszámla száma: 57600101-11102986
SWIFT (BIC): TAKBHUHB
IBAN: HU65 57600101 11102986 00000000
cégjegyzékszám: 06-09-014002
info:

Képgyűjtemény

Fiber lézervágó berendezés

CAXTC_LM_1325_2kW_J_1.0_Caxtool fiber lézervágó berendezés / Fiber cutting machine





Caxtool Kft.
6791 Szeged, Dorozsmai út 157. EU
+36 62 509 909
info@caxtool.hu
Adószám: 12871856-2-06
Adószám: HU 12871856

Bankszámla száma: 57600101-11102986
SWIFT (BIC): TAKBHUHB
IBAN: HU65 57600101 11102986 00000000
cégjegyzékszám: 06-09-014002
info:



- **Alkalmazási területek / Machine Application**

Widely used in sheetmetal processing, aviation, aerospace, electronics, electrical appliances, automobile, food machinery, textile machinery, engineering machinery, precision parts, ships, metallurgy equipment, elevators, household appliances, craft gifts, tool processing, decoration, advertising, and other fields. Professional used to cut sheet metal like carbon/mildsteel, stainless steel, aluminum alloy, galvanized sheet, electrolytic plate, titanium alloy, aluminum zinc plate, etc.

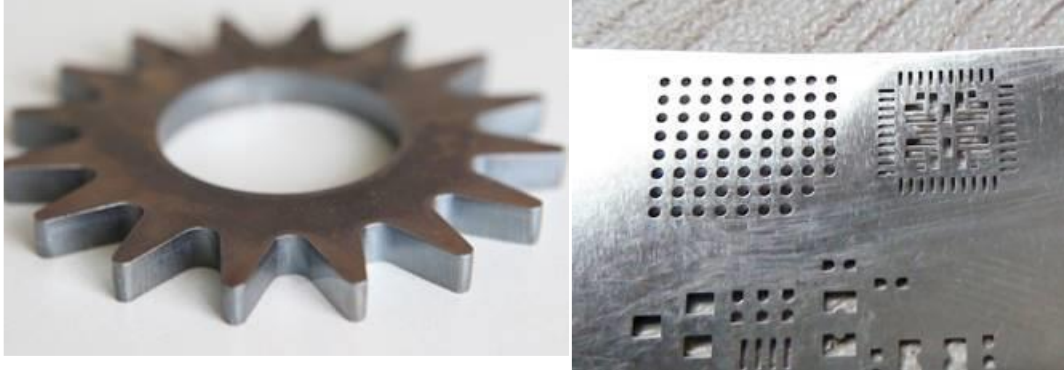

- **Lézer rezonátor / JPTCW 2000 Fiber Laser (2000W)**

JPT single mode fiber laser(500W-2000W) is the optimal combination of optical, mechanical, electrical and software components. Through the controlling ports and the controlling software, the operating status of the laser can be monitored in real time, alarm messages can be received in time, and data can be collected. The laser uses water-cooling and shelf case design, with competitive advantage like high energy conversion (electric to light), low power consumption, maintenance free, fiber delivery, and easy to assemble, it is the most suitable laser source for industrial laser welding, cutting and other applications.



	Unit	Parameter				
Nominal Average Output Power	W	500	800	1000	1500	2000
Beam Parameter Product	mm*mrad	<2 @50um				
Central Wavelength	nm	1080				
Spectral Width@3db	nm	<6				
Armored Cable Length	M	8			15	
Cooling Method		Water Cooled (Purified Water)				
Operating Voltage	V	Single-phase 220(AC)±10%			Three-phase 380(AC)±10%	
Maximum Power Consumption	W	1800	2700	3300	5000	7000
Switch on/off time	us	<20				
Maximum Modulation Frequency	khz	20				
Operation Temperature	°C	23 ~ 26				
Storage Temperature	°C	-20 ~50				
N.W	kg	36			83.5	
Size (W×D×H)	mm	483 × 484 × 133			483 × 800 × 178	

- Lézerfej / Laser Cutting Head RayTools BM109**



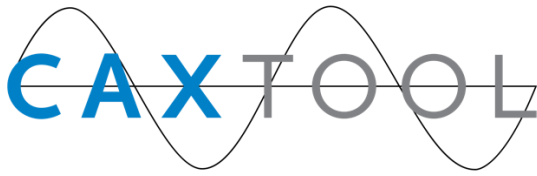

Caxtool Kft.
6791 Szeged, Dorozsmai út 157. EU
+36 62 509 909
info@caxtool.hu
Adószám: 12871856-2-06
Adószám: HU 12871856

Bankszámla száma: 57600101-11102986
SWIFT (BIC): TAKBHUHB
IBAN: HU65 57600101 11102986 00000000
cégjegyzékszám: 06-09-014002
info:

The BM109 series are auto-focusing laser cutting heads released by RAYTOOLS AG in 2017 for fiber laser processing with 1.5kW or less. This products have a built-in motor drive unit, which drives the focusing lens through a linear mechanism to change position automatically within 17mm. Customers can set the program to achieve continuous focus that completing the rapid piercing and cutting material with different thickness. BM109 use the D28 diameters lense set to collimate and focus the laser beam, which can achieve the diffraction-limited optical effect. The design of water-cooled structure allows laser heads to work stably and chronically

- Optimized optical configuration, smooth and efficient airflow design;
- Auto-focus range is +8~-9mm, Accuracy is 0.05mm;
- D28 diameters lens set, the maximum optical input power is 1.5KW;
- The maximum acceleration of the focusing lense is 10m/s², the maximum speed is 6m/min;
- The collimator lens and focusing lens are all protected by cover glass modules, which can effectively protect the collimator lens and focusing lens from contamination;
- Drawer-type of lens mount, quick and easy access to the cover glass;

Power Rating	≤1.5KW
Clear Aperture	26mm
Collimation protective glass	Φ 24.9mm*1.5mm
Focusing protective glass	Φ 27.9mm*4.1mm
Assist Gas Pressure	≤25bar
Weight	~3kg

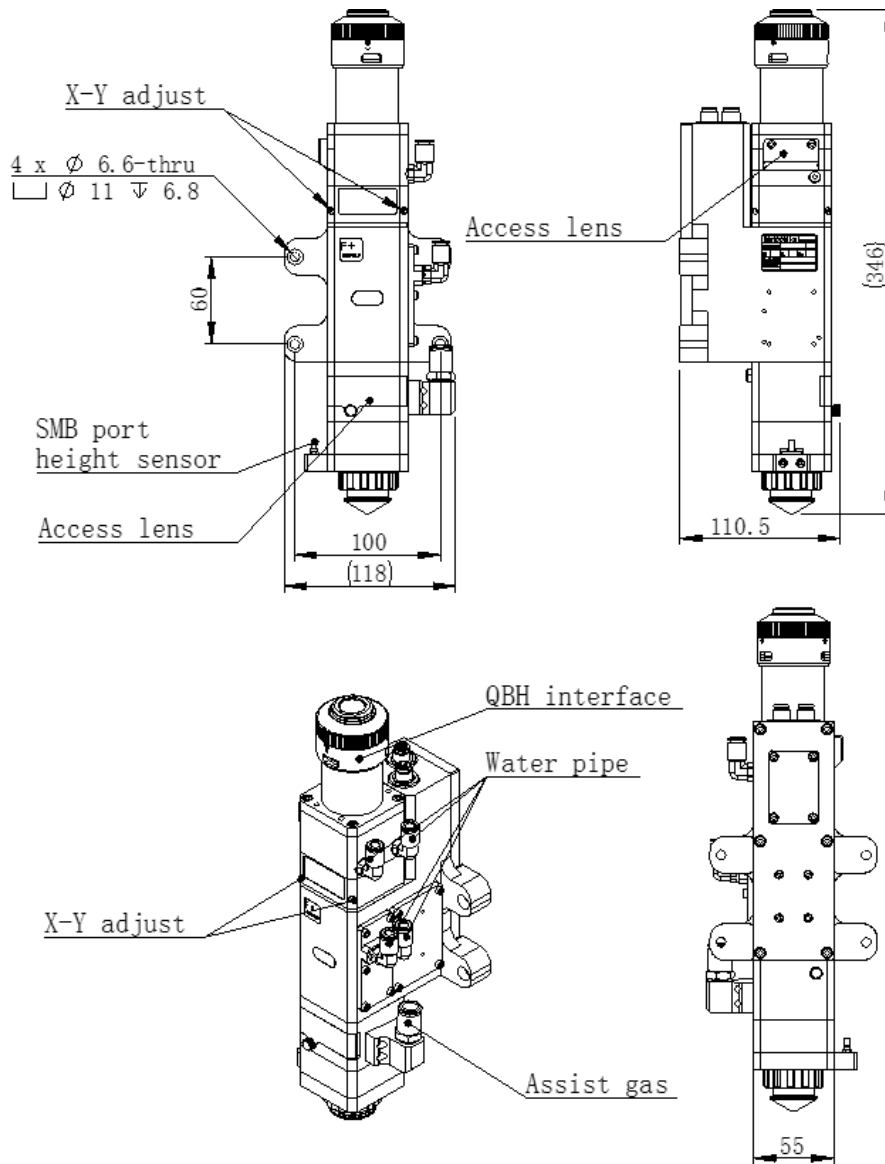

- **Cooling System S&A CWFL-2000**

S&A brand CWFL-2000 water chiller is specially applied to cool the fiber laser and optic lenses at the same time, multiple use for saving cost, space and manual move, quite convenient for the user.

S&A industrial water chiller has 2 temperature control modes as constant temperature and intelligent temperature control. Under intelligent mode, the water temperature is adjusted according to ambient temperature. You do not need to worry about the water temperature adjustment of seasonal changes.



Caxtool Kft.
6791 Szeged, Dorozsmai út 157. EU
+36 62 509 909
info@caxtool.hu
Adószám: 12871856-2-06
Adószám: HU 12871856

Bankszámla száma: 57600101-11102986
SWIFT (BIC): TAKBHUHB
IBAN: HU65 57600101 11102986 00000000
cégjegyzékszám: 06-09-014002
info:

CWFL-2000



✓ FIBER
LASER CHILLER

✓ $\pm 0.5^{\circ}\text{C}$



- **CNC Control System FSCUT2000C and Software CypCut**





FSCUT2000C laser cutting control system and its **CypCut** software integrates file reading, design, output, and processing control. It's able to complete the entire process from design to processing. The software, installed in an industrial computer, provides a wealth of laser cutting processing parameters, flexible layout and cutting path editing capabilities. CypCut Control system and software in English language, supporting files: DXF, PLT, AI, LXD, etc. Drawing in the software is possible. Software is with fly cutting mode for cutting same products to save time. The nesting function automatically arranges graphs to leave minimum spaces and save materials.

- **Lineáris rendszer elemei / Transmission System**



Machine is with Taiwan YYC gear rack and PMI linear rail transmission, which ensures machine high speed movement, precision and stability as well.

- **Vezetékrendszer kenése / Auto Lubrication**



It automatically lubricates guide rails, which ensures the machine keep moving smoothly and with good precision.

- **Füst elszívó ventilátor / Exhaust System**



A 2.2Kw centrifugal exhaust fan strongly removes the fumes and dusts caused during cutting.

- **Gázvezérlő szelep / Gas Assist Valves (Solenoid Valve, SMC Proportional Valve)**



Gas assists cutting either in cutting speed, cutting thickness or cutting effect.

For example, oxygen helps to cut faster and thicker; nitrogen helps to get brighter cutting edge.

The solenoid valve controls the gas blowing. Gas blows only during cutting, which saves your gas cost. SMC proportional valve controls the gas pressure and brings good cutting all the time, for example, gas pressure is lowered when cutting corners.

- **Gépágy / Machine Body**



- **Gépasztal / Machine Table**



Caxtool Kft.
6791 Szeged, Dorozsmai út 157. EU
+36 62 509 909
info@caxtool.hu
Adószám: 12871856-2-06
Adószám: HU 12871856

Bankszámla száma: 57600101-11102986
SWIFT (BIC): TAKBHUHB
IBAN: HU65 57600101 11102986 00000000
cégjegyzékszám: 06-09-014002
info:



Saw-shape machine table holds metal sheet steady with little touch with metal sheet. The saws are thick and durable.

- **Lézervédelmi burkolat / Full cover with CE security glass (OPTION)**

In front door, the glass is CE security glass. Machine left and right side, they are normal glasses.



Caxtool Kft.
6791 Szeged, Dorozsmai út 157. EU
+36 62 509 909
info@caxtool.hu
Adószám: 12871856-2-06
Adószám: HU 12871856

Bankszámla száma: 57600101-11102986
SWIFT (BIC): TAKBHUHB
IBAN: HU65 57600101 11102986 00000000
cégjegyzékszám: 06-09-014002
info:

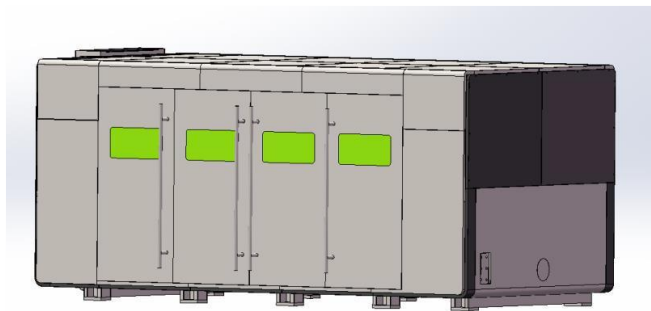
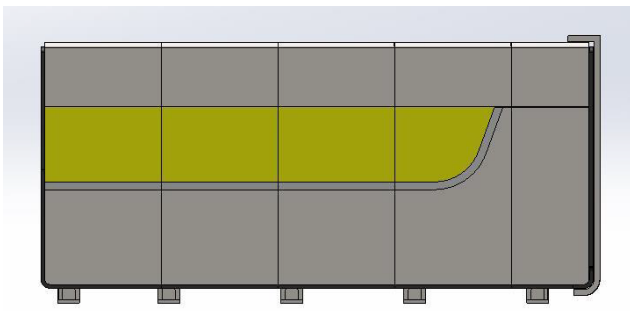
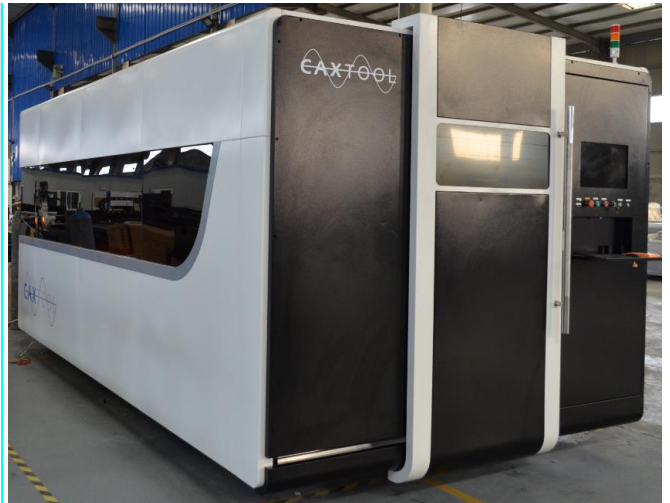

- **Lemez behelyezése lézervédelmi burkolat esetén / Material Loading System (OPTION)**

The machine has folding doors at right side, through which you can load the metal sheets to the machine table. For easier loading of metal sheet, we build the machine with nylon shaft besides the machine table. The shaft is higher than the machine table and Y-axis movement structure, so the metal sheet won't be blocked. Nylon shaft (instead of metal shaft) will not scratch the metal sheet.

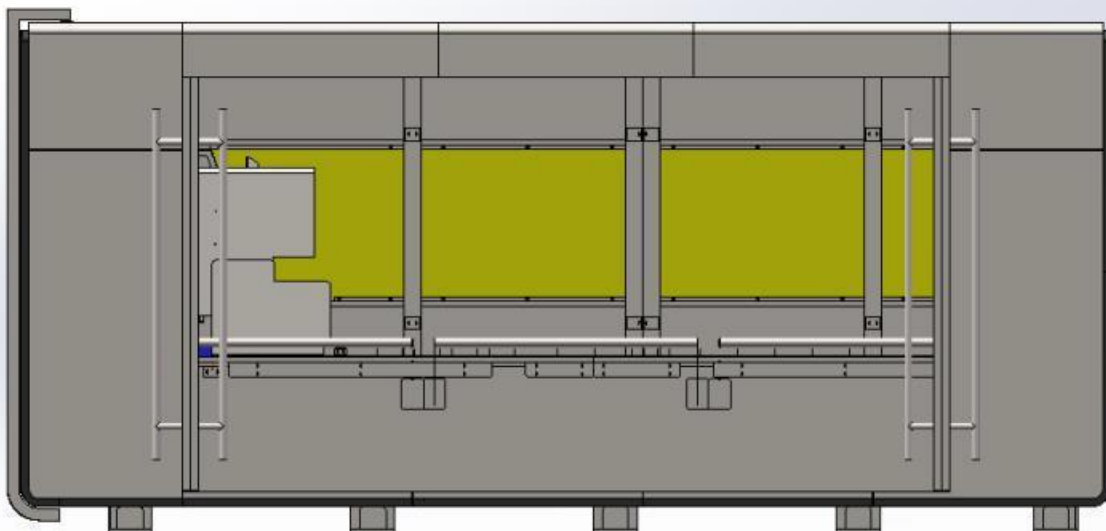
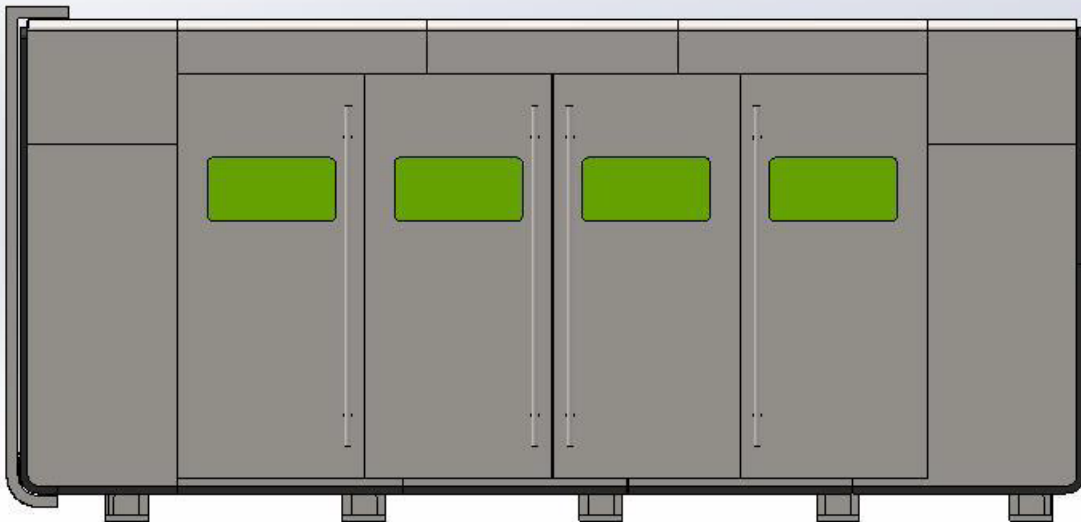

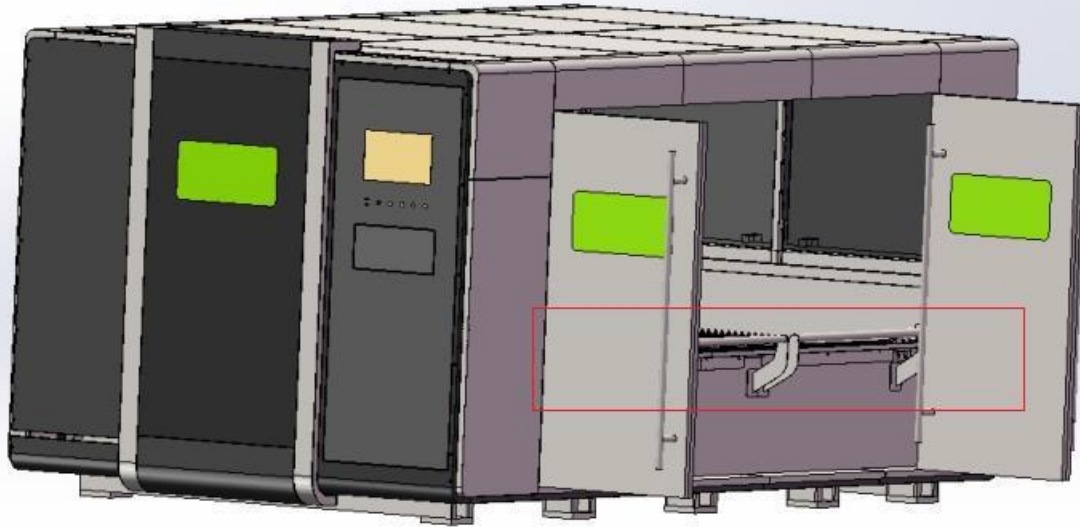

Nylon shaft assisting metal sheet loading

- Lézervédelmi szemüveg / Safety goggles

